

institute
imdea
energy



Presentation

www.energy.imdea.org

IMDEA Institutes

- IMDEA is a network of research centers.
- Regional level.
- Seven autonomous institutes.
- Operational since 2007.
- About 400 researchers.





IMDEA Energy Institute

- Not-for-profit R&D Foundation.
- Legally founded in 2006 by Madrid's Government.
- Activity began in 2007.
- Mission: promote and carry out R&D activities for the development of a sustainable energy system with special emphasis on renewable and clean energy technologies.
- Organized into six research units.



Organisation Structure

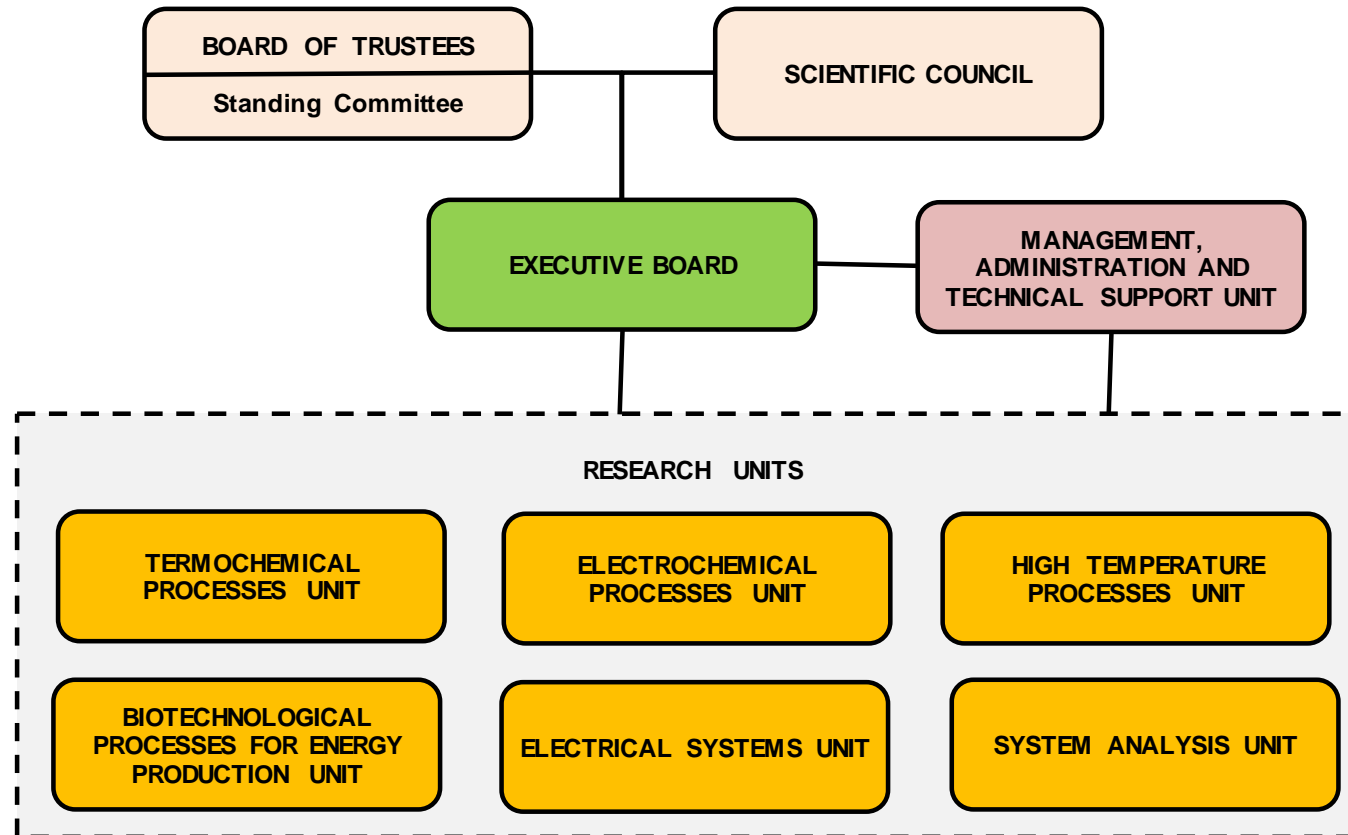

Research lines

- **Production of sustainable fuels:** hydrogen and biofuels.
- **Solar power.**
- **Energy storage:** electrochemical, thermal and thermochemical systems.
- **Energy systems with enhanced efficiency:** capacitive deionisation.
- **Smart management of electricity.**
- **Confinement and valorization of CO₂.**

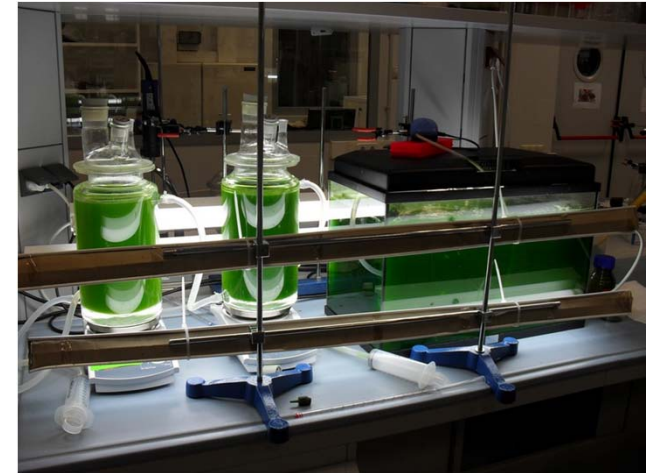

Staff

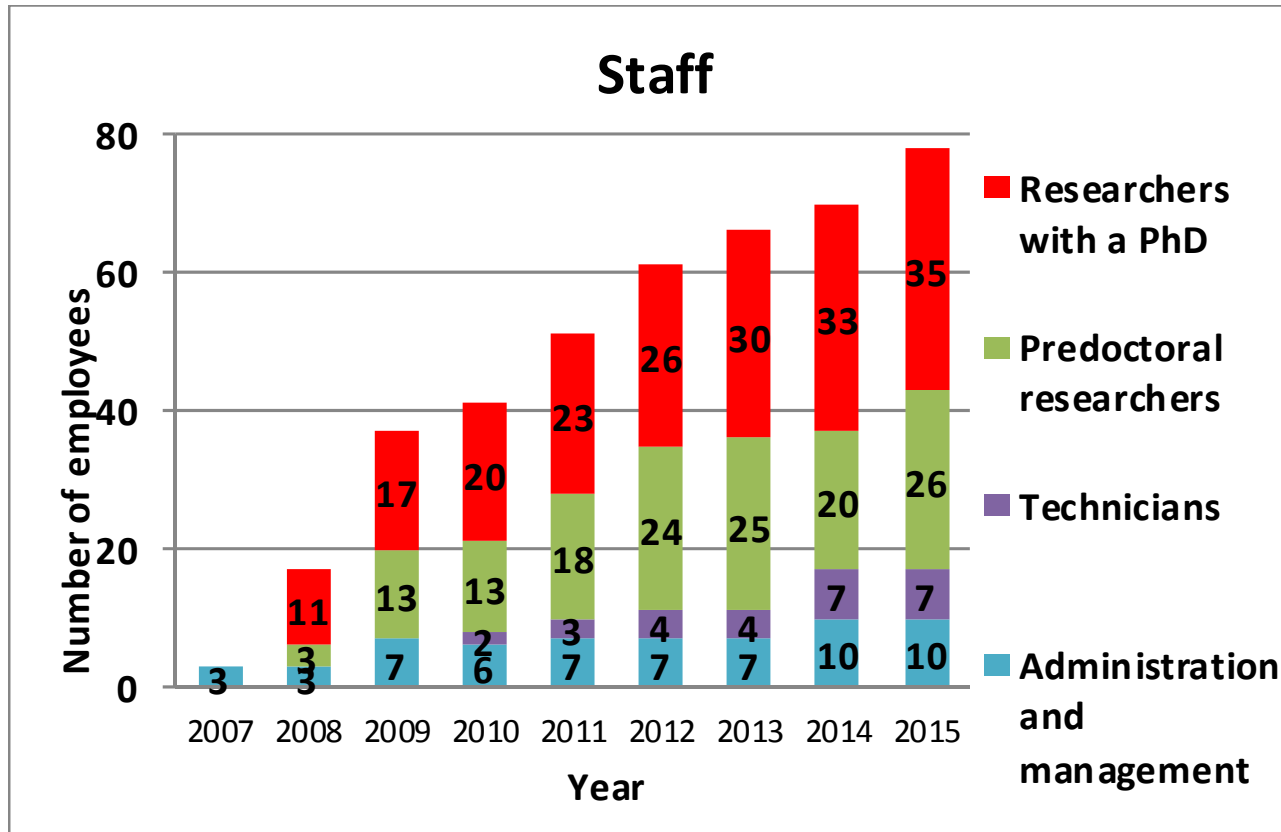

Roughly 1/3 foreigners, including about 15 nationalities

Type of activity	Number of students 2014
B.Sc and M.Sc final projects	19
Internships	25
Total	44



External funding

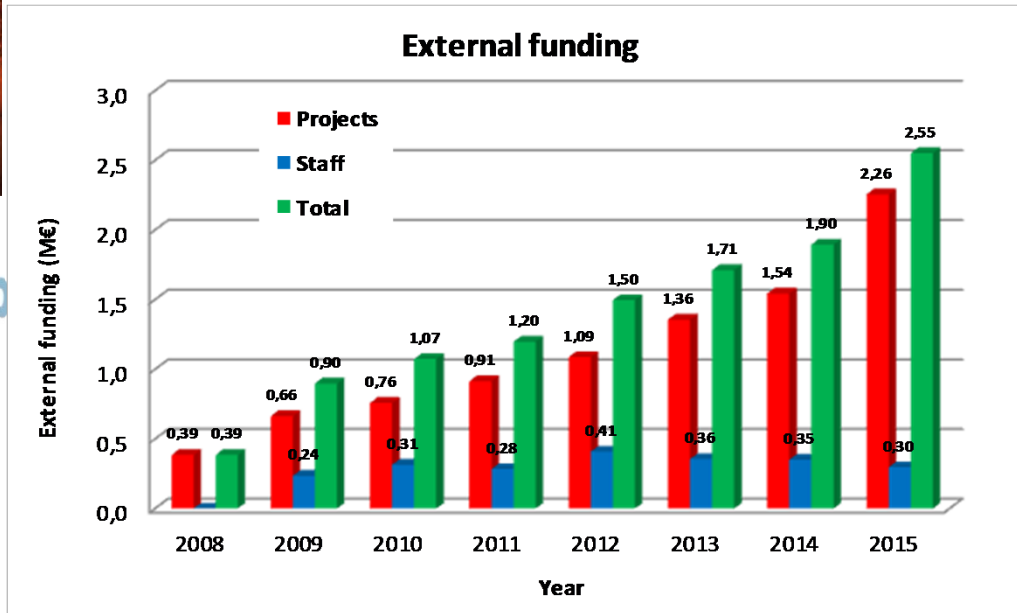

PROJECTS	Alive	Requested
Internationals	7	10
Spanish	16	13
Company contracts	8	2

Coordination of an international project with 17 partners and budget > 9 M €.

Staff funding:

- Programme AMAROUT Marie Curie.
- Programme Ramón y Cajal.
- Programme Juan de la Cierva.
- Predoctoral grants FPI.
- Iberdrola Foundation Fellowships.

External funding from projects

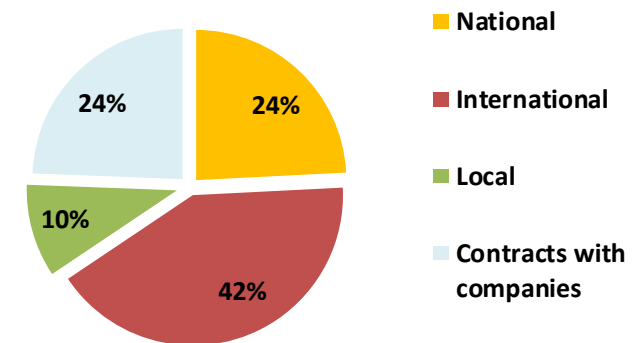

Scientific publications in indexed journals (Scopus)

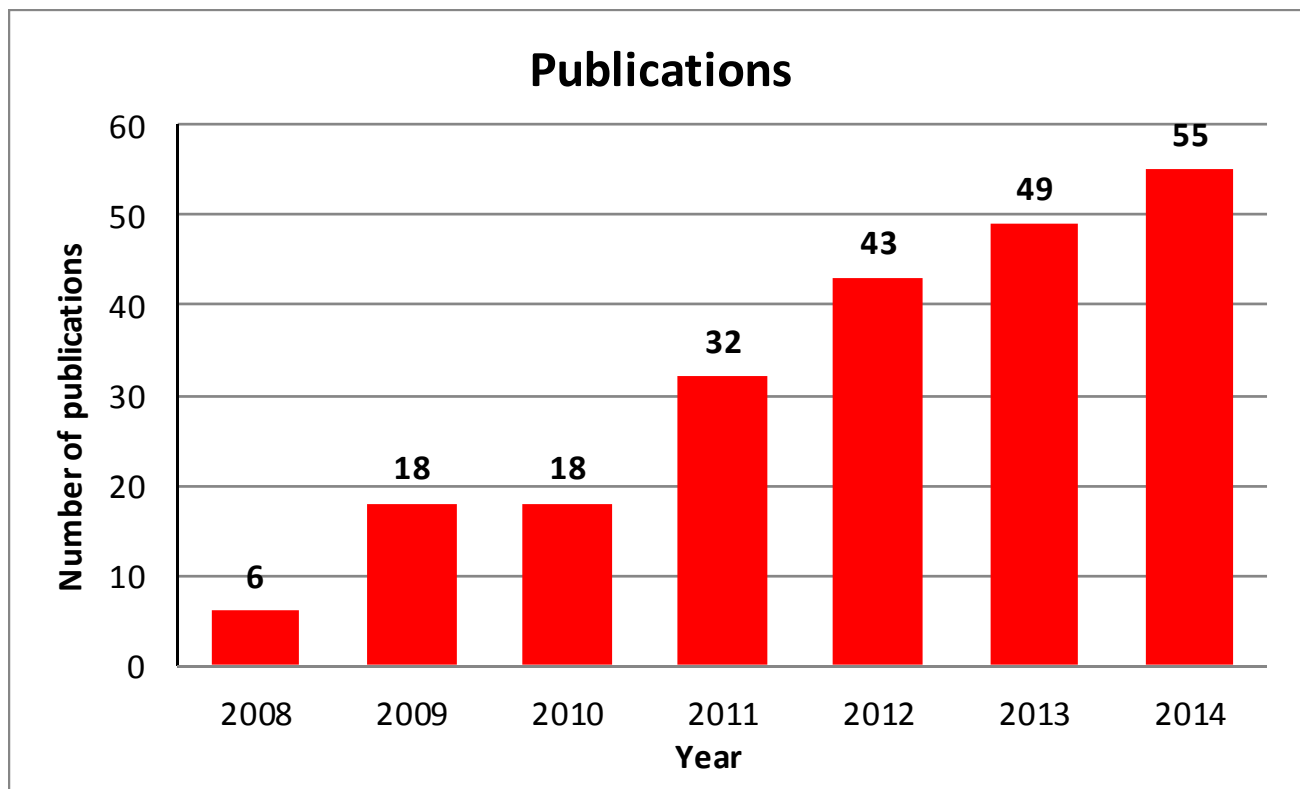

COMMUNICATIONS TO CONGRESSES
IN 2014: 57 (18 invited)

Energy & Environmental Science

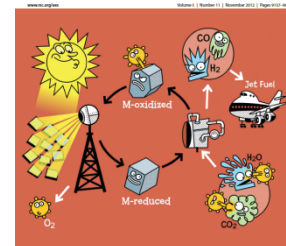

RSC Publishing





institute
imdea
energy

www.energy.imdea.org

Technological Services

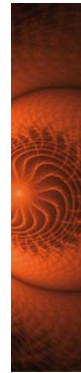

Capabilities (I)

- **Management and life cycle analysis:** LCA, LCA+DEA, LCC, “emergy” analysis, carbon footprinting and analysis in support of environmental declarations applied to products, processes and services.
- **Process simulation and feasibility studies,** thermodynamic analysis, energy and exergy balance, socio-economic, techno-economic and sustainability studies and scenarios.
- **Synthesis and characterisation** of catalysts, materials for high temperature and energy storage, nanoparticles sol-gel, coating of electrodes and electrochemical cells.
- **Proactive management of power networks and conversion of electrical energy.** Static and dynamic modelling of power networks and microgrids. Real-time control. Design and control of power electronics interfaces.
- **Optical-mechanical engineering** and optical-energetic characterisation systems. Characterisation and simulation of high flows of solar radiation and high temperatures: thermal imaging systems, CCD and CMOS cameras, pyrometry and calorimetry.

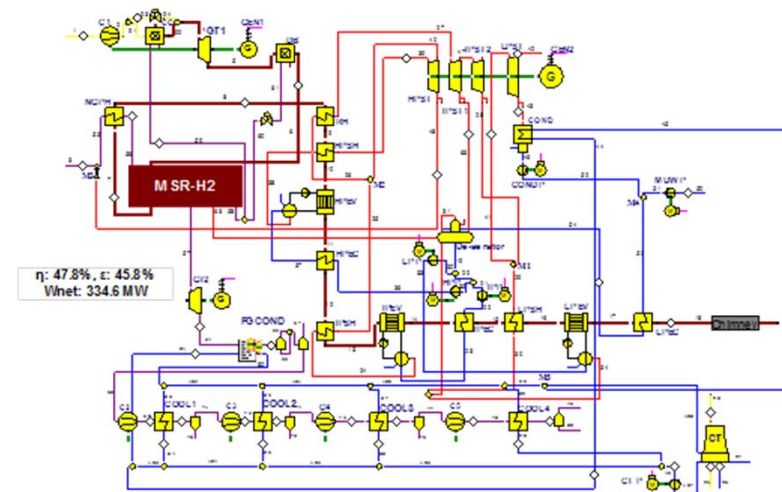
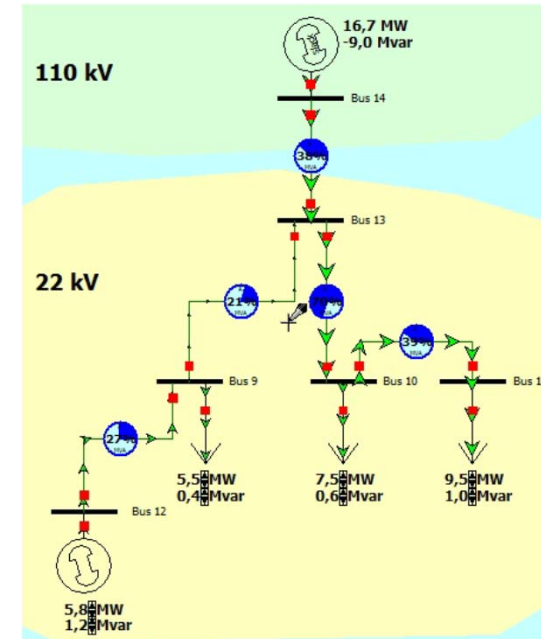



Capabilities (II)

- **Simulation and modeling:**
 - Thermal fluid dynamics, CFD (COMSOL Multiphysics).
 - Process simulation and data processing (Matlab-Simulink).
 - Electric (IPSA, PowerWorld).
 - Ray tracing (TracePro).
 - Annual performance (STEC/TRNSYS).
 - 3D computer-aided design (SolidWorks).
 - Data acquisition and process control (LabVIEW).
 - Calorimetric loops.
- **Technology watch and foresight** on renewable energy and energy technologies.

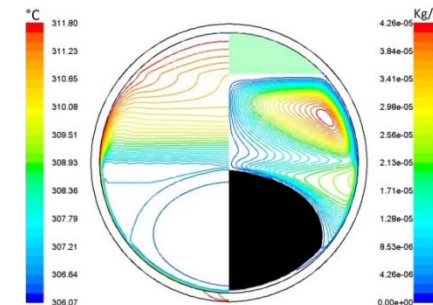
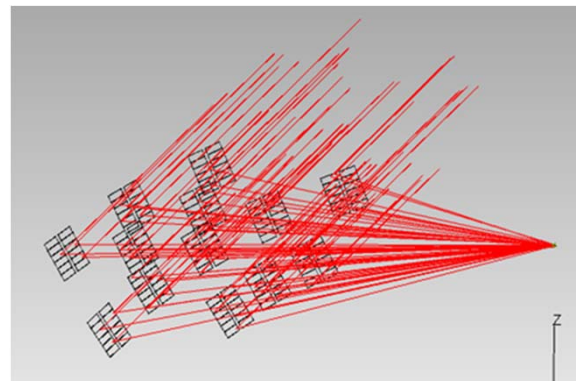
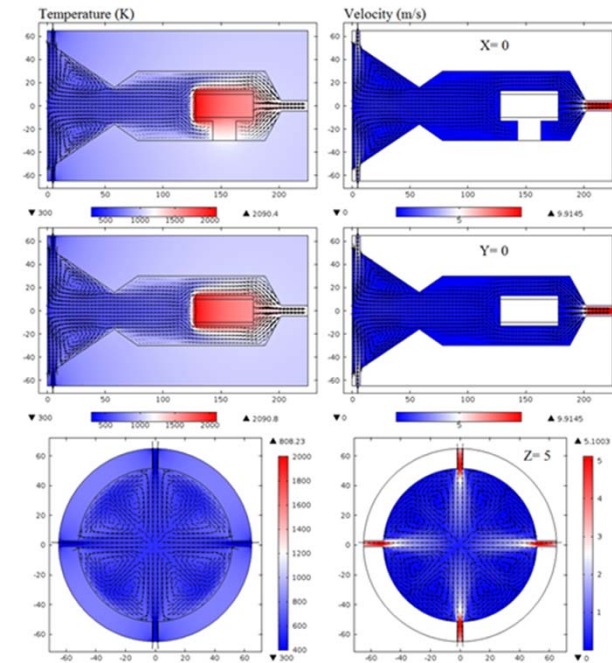



Pilot plant facilities

- **High-flux solar simulators of 7 and 42 kW.** Surface treatment and synthesis of materials. Advanced solar concentration optics. Solar receivers and reactors. Thermal fluids for high temperature applications.
- **Smart Energy Integration Lab SEIL.** Real-time emulation of AC and DC power networks and microgrids. Development of optimal dispatch algorithms for energy resource management. Stability analysis, power quality and control strategies for microgrids and power electronics converters.
- **Test Installation for batteries and electrochemical capacitors EDTL** with various assay protocols in DC and AC. Simulation of demand cycles in powers from 0.3 to 30 kW under controlled temperature and humidity.
- **Production and conversion of biomass** in open and closed photobioreactors. Pyrolysis (thermal or catalytic) on fluidised bed reactor and hydrodeoxygenation on fixed bed reactor, coupled to systems of volumetric and chromatographic analysis.



Instrumental techniques

- **Chemical characterisation techniques:** mass spectrometry, gas/mass chromatography. Elemental analysis ICP-OES and CHONS.
- **Thermogravimetric analysis (TG-DTA)** in an oxidising (air), inert (Ar) or reductive (10% H₂/Ar) atmosphere.
- **Properties of solids:** textural and chemisorption.
- **X-ray diffraction** with structural analysis PDF and controlled atmosphere chamber up to 900 °C and 10 bar.
- **Spectroscopy:** IR (DRIFT, ATR and VEEMAX), UV-vis-NIR, Raman and Fluorescence.
- **Thermal Diffusivity determination.**
- **Microscopy:** Atomic force with next probe, SEM scanning electron and optical.
- **Biotechnological characterisation techniques:** GC, HPLC equipped with different columns and detectors (IR, MS, UVVIS, HPAEC-PAD). Electrophoresis instrumentation for recombinant DNA technology, protein purification and analysis.





institute
imdea
energy

www.energy.imdea.org

Research topics



Solar energy and high temperature

Objectives

- Concentrating solar power systems engineering.
- High temperature components and applications.
- Production of solar fuels and chemicals.



Research lines

- ✓ Solar concentration plants for high efficiency and integration in urban environments.
- ✓ Solar concentrators, heliostats and optical engineering.
- ✓ Advanced thermal fluids.
- ✓ Solar receivers and reactors.
- ✓ Development of techniques for characterisation and simulation of high flows of solar radiation and at high temperatures.
- ✓ Integration of solar technologies for thermal, electric and hydrogen production contribution.
- ✓ Reduction of metal oxides, solar assisted combustion.



Sustainable fuels

Objectives

- Production of H₂: CH₄ decomposition, thermochemical cycles.
- Production of biofuels from biomass.

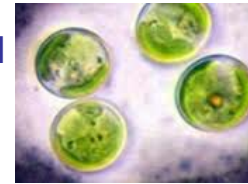

Research lines

- ✓ Catalysts for H₂ and advanced biofuels production.
- ✓ Production of high value-added materials: graphene and carbon nanotubes.
- ✓ Enzymatic treatment and pyrolysis of lignocellulosic biomass.
- ✓ Biorefineries.
- ✓ Production of microalgae to obtain biofuels.
- ✓ Genetic modification of microorganisms to increase the production of biofuels.
- ✓ Production of biofuels from municipal solid waste.





Energy storage

Objectives

- Storage coupled to renewable sources.
- Sustainable mobility.

Research lines

- ✓ Materials for high energy density capacitors and advanced batteries.
- ✓ Thermochemical storage using ceramic materials and redox systems.
- ✓ Design and modelling of electrochemical reactors:
 - ✓ flow batteries,
 - ✓ metal-air batteries and
 - ✓ supercapacitors.
- ✓ Characterisation and testing of electrochemical energy storage devices at laboratory and pilot plant scales.

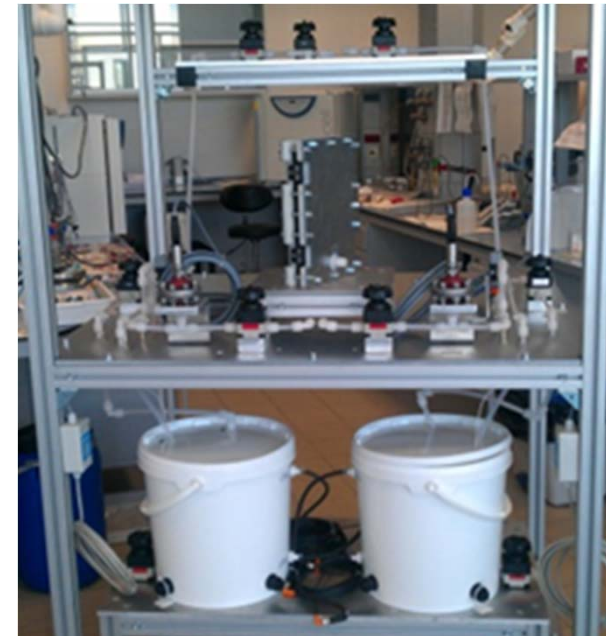
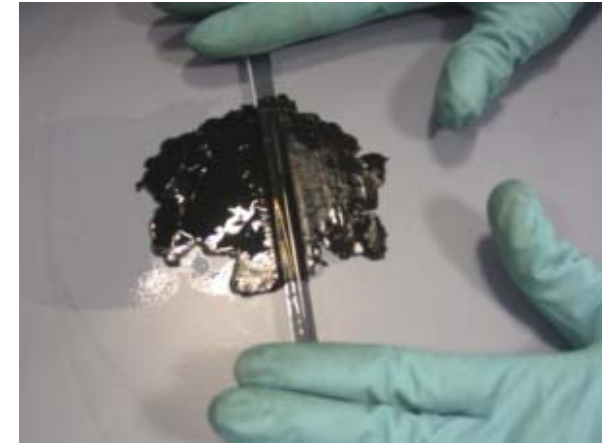

Management of electrical energy resources

Objectives

- Proactive energy resource management for distribution networks and microgrids.
- Integration of renewable and energy storage devices.

Research lines

- ✓ Management algorithms for distribution networks.
- ✓ Power networks and microgrid modelling and stability analysis.
- ✓ Design and control of power electronics converters.
- ✓ Reliability analysis of power networks with high share of renewables: solar, wind...
- ✓ Techno-economic and feasibility studies for electrical systems.

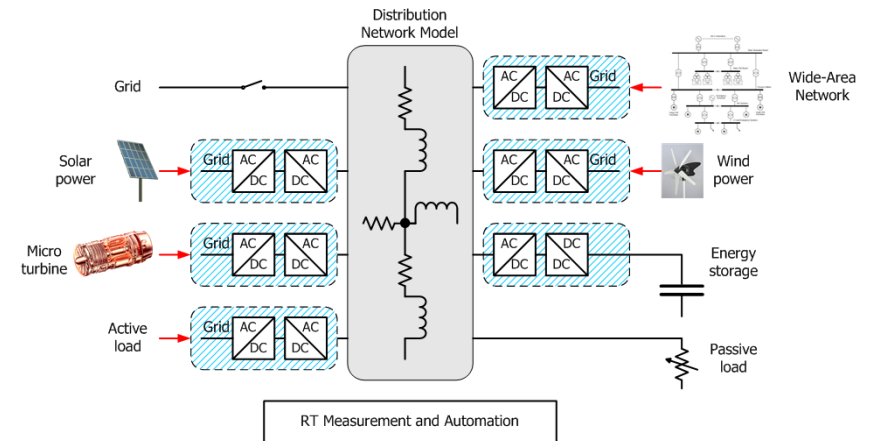

Energy systems with enhanced efficiency

Objectives

- Energy saving and efficiency.
- Optimised use of energy resources.

Research lines

- ✓ Demand management and energy efficiency in buildings, residential and commercial sector.
- ✓ Optimisation of energy supply mix.
- ✓ Management of energy resources in industrial applications.
- ✓ Energy efficiency application in vibration test systems.
- ✓ Capacitive deionisation for energy efficient water treatment.

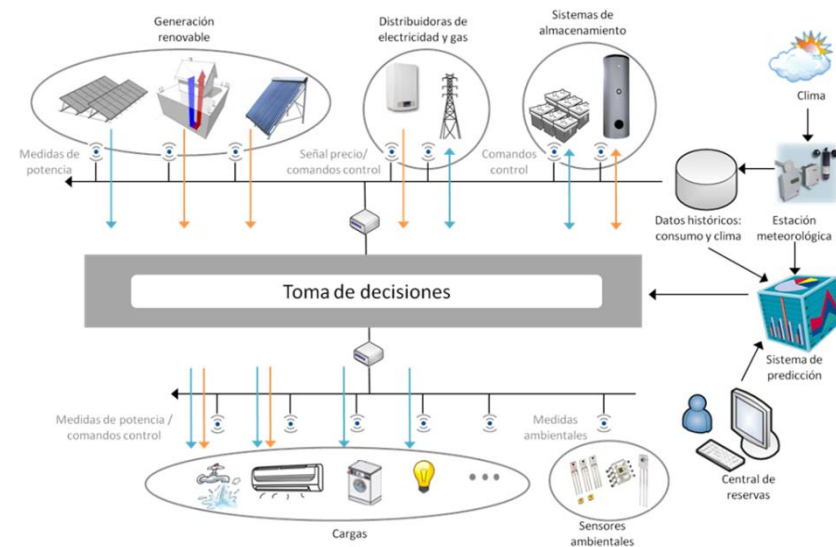

CO₂ capture and valorisation

Objectives

- Photochemical valorisation of CO₂.
- Study of techniques for CO₂ capture and storage.

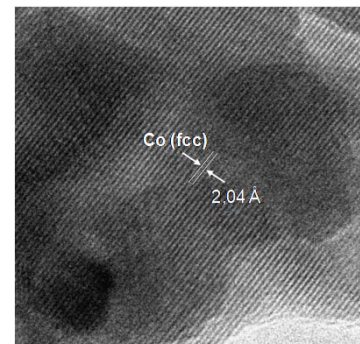

Research lines

- ✓ Catalysts for photocatalytic reduction of CO₂.
- ✓ Analysis of techniques for CO₂ capture and storage:
 - Life cycle
 - Environmental and
 - Techno-economic studies.

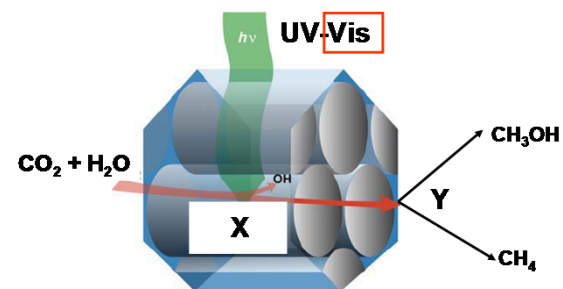



institute
imdea
energy

www.energy.imdea.org

High Temperature Processes Unit

Objectives

- Concentrating solar power systems engineering.
- High temperature components and applications.
- Production of solar fuels and chemicals.

Research lines

- ✓ Solar concentration plants for high efficiency and integration in urban environments.
- ✓ Solar concentrators, heliostats and optical engineering.
- ✓ Advanced thermal fluids.
- ✓ Thermal storage: materials and modellisation.
- ✓ Solar receivers and reactors.
- ✓ Development of techniques for characterisation and simulation of high flows of solar radiation and at high temperatures.
- ✓ Integration of solar technologies for thermal, electric and hydrogen production contribution.
- ✓ Reduction of metal oxides, solar assisted combustion.
- ✓ Simulation: solar simulator, thermodynamic cycles, calorimetric loops.



HIGH TEMPERATURE PROCESSES INTEGRATION & PERFORMANCE

- Efficient integration schemes in power conversion systems

Projects: Alcones, SolarO2, SolH2, ADEL, TCSPower, CSP2, eON

Outcomes:

- Modules and components for energy analyses of CSP plants (dual receivers, integration of HT electrolysers)
- Software for energy analyses of renewable energy integration in buildings

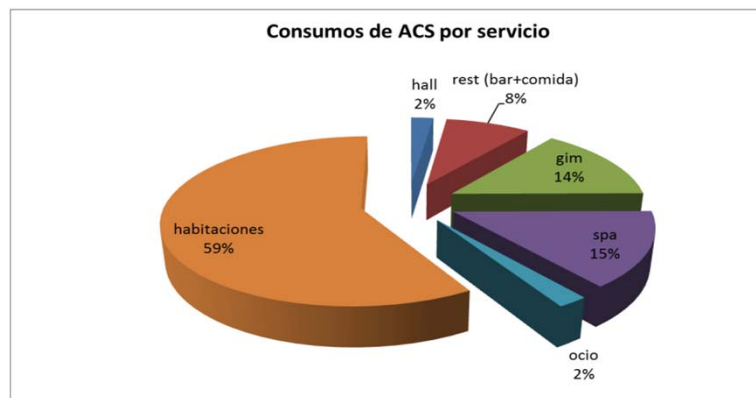
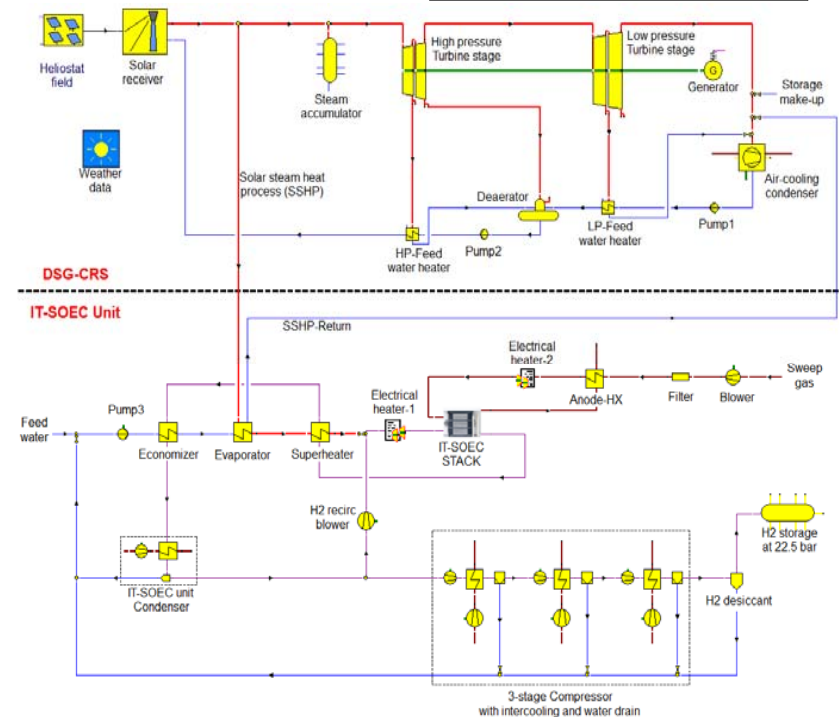
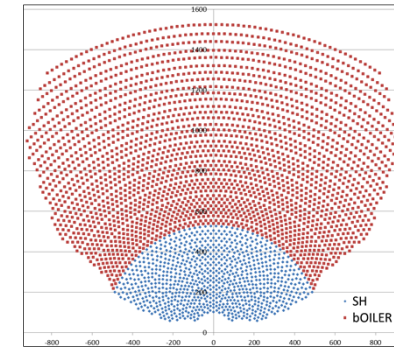



SOLAR CONCENTRATION

- Modular concepts with minimum environmental impact
- Solar concentration optics

Projects: Alcones, CrispTower, SolH2, SolarO2

Outcomes:

- Development of an original modular concept.
- Characterization of a new carousel-type heliostat for CSP
- Optical design of high-flux solar simulator 42 kW_e
- Software for solar fields dimensioning

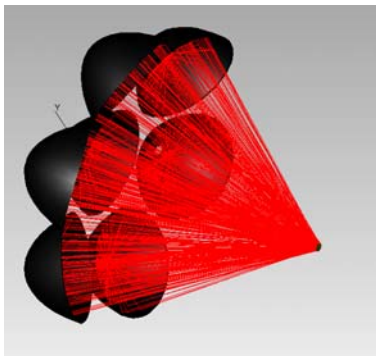

High Temperature Processes Unit

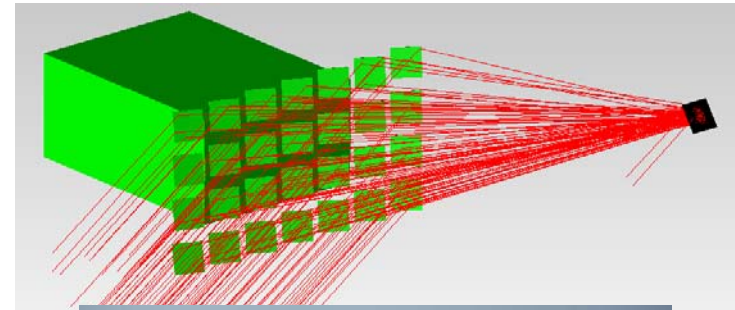



SOLAR RECEIVERS & NEW HEAT TRANSFER FLUIDS

- Solar receivers and reactors
- Advanced thermal fluids for high temperature applications
- High flux/high temperature characterization techniques and simulation tools

Projects: Alcones, CrispTower, SolarO2, CSP2

Outcomes:

- Calorimetric loop for the characterization of materials for metallic and ceramic volumetric absorbers
- CFD models for receivers simulation

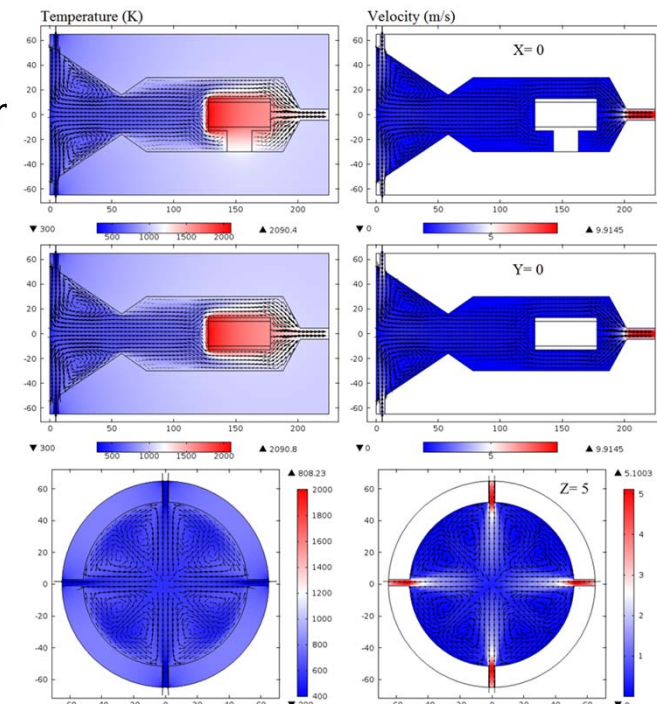
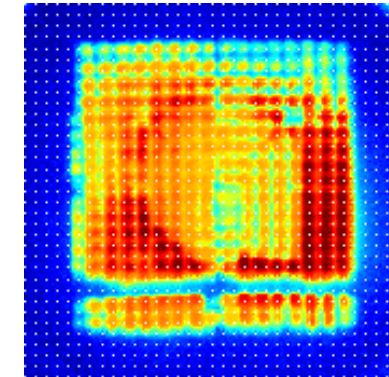



ENERGY STORAGE & SOLAR THERMOCHEMISTRY

- Thermal heat storage (phase change and thermochemical) for CSP plants
- Solar-driven high temperature production of H₂ /Chemicals

Projects: Alcones, SolarO₂, SolH₂, TCSPower, eON

Outcomes:

- Test bed characterization of thermochemical energy storage systems based on redox reactions with metallic oxides.
- High-flux thermochemical reactor and CFD models.
- CFD models for packed bed and PCM pellets

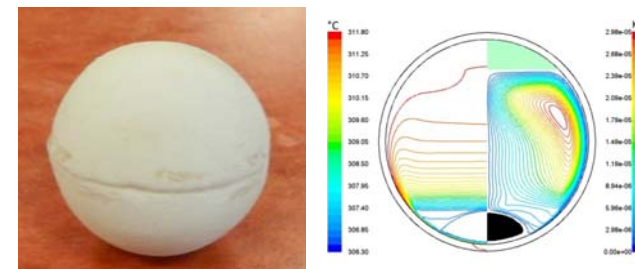
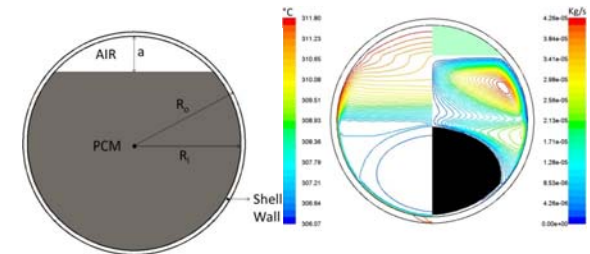
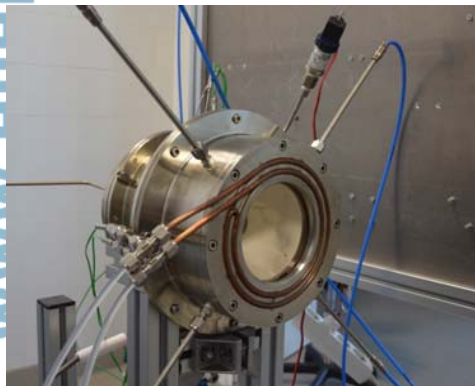
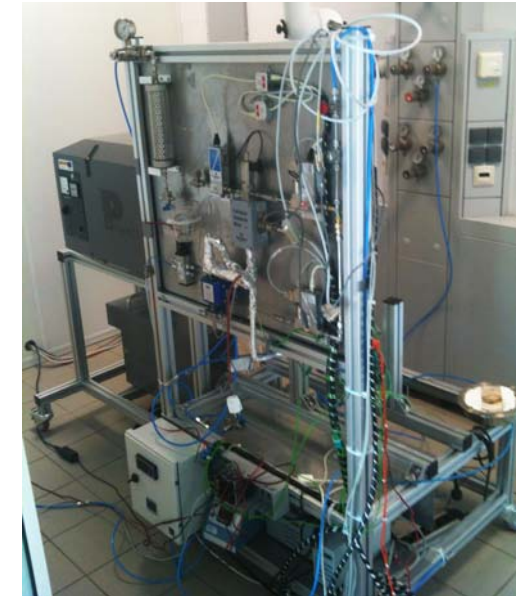

Collaboration with companies

The image displays a grid of logos for various companies. A central box highlights the logos for IBERDROLA, REPSOL, and ABENGOA. The logos are arranged in a grid with a central box highlighting IBERDROLA, REPSOL, and ABENGOA.

KitoZyme	GreenPower tech	IBERDROLA	PROINGESA PROYECTOS, INGENIERIA Y GESTION, S.A.	SyV Sacyr Vallehermoso
P&G	ELYTT ENERGY	REPSOL	acciona	
ZIGOR corporación s.a.	ISOLUX CORSÁN	ABENGOA	Torrresol Energy reinventing solar power	skeletontech
B/E AEROSPACE	EINSA equipos industriales de manutención s.a.	Solintel	e-on	triphas Smart inverters for R&D
nANOQUIMIA	SIEMENS	HYNERGREEN	solvionic	IPRESARIOS AGRUPADOS
ERACHEM COMILOG	SOFCPOWER SOLID OXIDE FUEL CELLS	comessa®	TOPSOE FUEL CELL RETHINKING ENERGY	BUHLER
accelopment® takes you further	HTceramix	HYGEAR	IMV CORPORATION SECURE THE FUTURE	BEFESA
imesAPI Servicios · Movilidad	ence ENERGÍA & CELULOSA	eni	SILKEM	Groupe ERAMET

Networking

Spanish



Spanish Technology Platforms



Internationals



www.energy.imdea.org



institute
imdea
energy

institute
imdea
energy